

ShenZhen Yes-Display International Technology CO.,LTD. 深圳市亿显国际科技有限公司			4.3 Inch UART Display Module 4.3 寸串口显示屏	
File NO.		REV	A/01	http://www.yes-display.com

UART Display Module

Module: YS-CB-0430LT16M-06D V1.0

Designed by	R&D Checked by	Quality Department by	Approved by

Approval by Customer:

OK

NG, Problem survey

Approved By _____

ShenZhen Yes-Display International Technology CO.,LTD. 深圳市亿显国际科技有限公司			4.3 Inch UART Display Module 4.3 寸串口显示屏	
File NO.		REV	A/01	http://www.yes-display.com

Revision Record / 版本记录

REV NO.	REV DATE	Contents Before Change	Contents After Change	Note
V1.0	2022/8/26	NEW		

ShenZhen Yes-Display International Technology CO.,LTD. 深圳市亿显国际科技有限公司			4.3 Inch UART Display Module 4.3 寸串口显示屏	
File NO.		REV	A/01	http://www.yes-display.com

Contents / 目录

List	Description	Page No.
	Cover / 封面	1
	Revision Record / 版本记录	2
	Contents / 目录	3
1	Hardware Introduction / 硬件介绍	4
2	Product Application Diagram / 产品应用图	6
3	Outline Dimensions / 产品尺寸	11
4	Interface Definition / 接口定义	14
5	Product technical parameters / 产品技术参数	15
6	Reliability Test Conditions and Methods / 可靠性实验测试	18
7	PC Software / PC端应用开发软件	19
8	Packing Method / 包装方式	28

1. Hardware Introduction / 硬件简介

1.1 Hardware Introduction / 硬件指导



ShenZhen Yes-Display International Technology CO.,LTD. 深圳市亿显国际科技有限公司			4.3 Inch UART Display Module 4.3 寸串口显示屏	
File NO.		REV	A/01	http://www.yes-display.com

1.2 Debug Tool / 调试工具

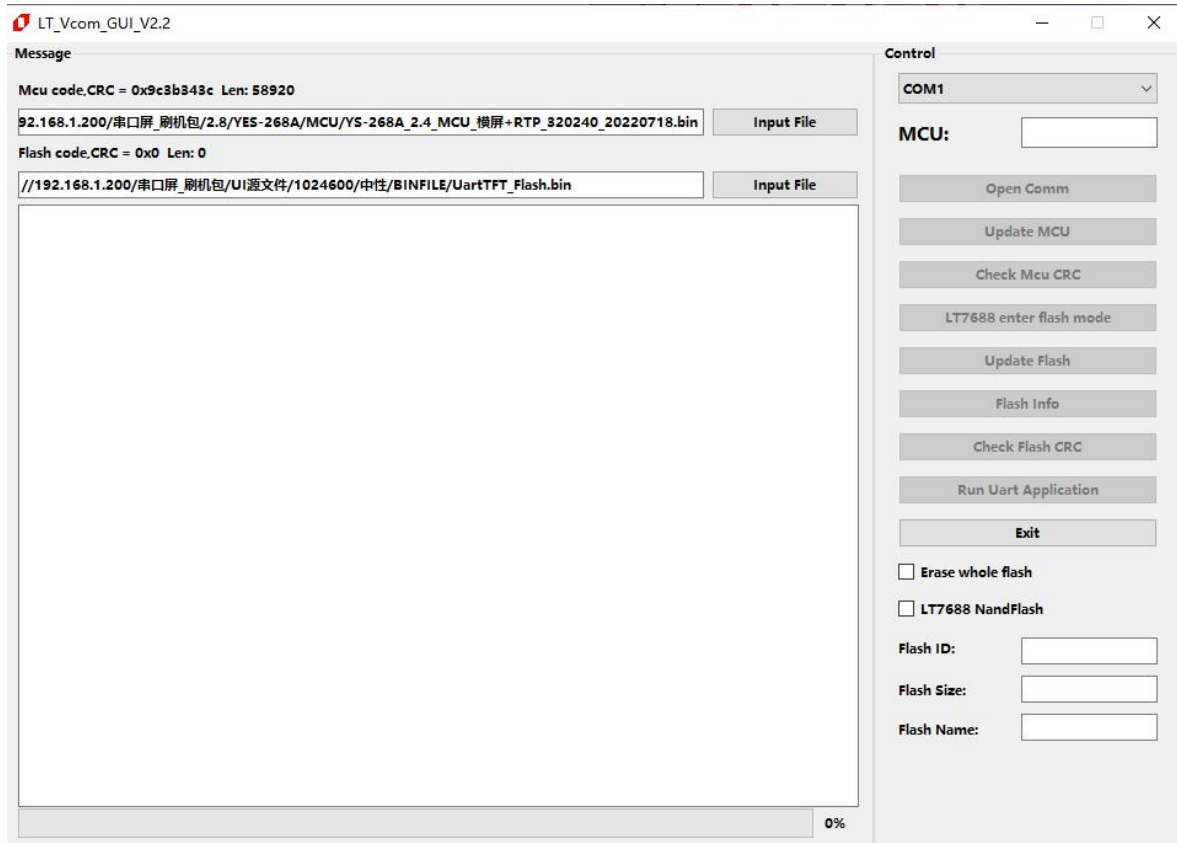

ShenZhen Yes-Display International Technology CO.,LTD. 深圳市亿显国际科技有限公司			4.3 Inch UART Display Module 4.3 寸串口显示屏	
File NO.		REV	A/01	http://www.yes-display.com

2. Product Application Diagram / 产品应用图

2.1 Chip-set Introduction / 主核芯片介绍

UART YS-88 is an efficient Serial Uart TFT Panel controller. Its internal combination of YES-DISPLAY's 32bit MCU and TFT graphics accelerator (YS-88 driver). The main function is to provide Uart, USB serial port communication, so that the upper computer MCU can easily display the content to the TFT panel to the TFT driver through simple command. In addition, the internal hardware also provides graphics acceleration, PIP (picture-in-picture), geometric graphics drawing and other functions, which can improve TFT display efficiency and reduce the time spent by MCU in processing graphics display. The YS-88 driver supports TFT display resolution from 320*240 (QVGA) to 1280*1024 (SXGA), and the display supports 16/18bits of RGB interface.

UART YS-88 串口屏控制芯片其内部结合了 32bit MCU 及 TFT 图形加速器的核心架构，主要的功能就是提供 Uart、USB 串口通讯，让主控端 MCU 透过简易的指令就能轻易的将要显示到 TFT 屏的内容传递给 TFT 驱动器 (Driver)，除了自带 32 位 MCU 之外，内部硬件还提供图形加速、PIP (Picture-in-Picture)、几何图形绘图等功能，能够提升 TFT 显示效率，及降低 MCU 处理图形显示所花费的时间，YS-88 MCU 支持的 TFT 显示分辨率，可以由 320*240 (QVGA) 到 1280*1024 (SXGA)，显示屏则支持 16/18bits 的 RGB 接口。

The internal 32-bit MCU frequency of YS-88 can reach 72MHz, with 64Kbytes Flash and 8Kbytes SRAM. In addition to providing Uart, USB serial port communication, but also provide some analog input AIN, PWM and INT interrupt interface, these interfaces can also be set up as normal I/O interface. The YS-88 has built-in 128Mb display memory to achieve multi-layered and high-resolution display, which can support color ranging from 2 gray scales per pixel of 1bit to 262K colors of up to 18bits per pixel. YS-88 also has a built-in geometric drawing engine, which supports drawing points, lines, curves, ellipses, triangles, rectangles, rounded rectangles and other functions. At the same time, the built-in hardware graphics acceleration engine (BTE) provides graphics operations such as display rotation, image mirrorizing, picture-in-picture and transparent display of graphics. If with Yes-Display's upper and lower computer software can play its display efficiency, and do not need to upgrade MCU for TFT panel. YS-88 powerful display function is very suitable for the use of TFT panel on electronic products, or the original use of monochrome panel and want to upgrade the product, such as a variety of intelligent appliances, motor vehicle dashboard, multi-functional transaction machine, industrial control, electronic instruments, medical equipment, human-machine interface, testing equipment and other products. The following is the application block diagram of YS-88.

芯片内部的 32 位 MCU 主频可达 72MHz，含有 64Kbytes Flash、8Kbytes SRAM，除了提供 Uart、USB 串口通讯，也提供一些模拟输入 AIN、PWM 及 INT 中断接口，这些接口也可以设置成普通 IO 接口，而为了达到多层次高分辨率的显示效果，芯片内建 128Mb 显示内存，可以支持从每像素 1bit 的 2 灰阶到高达每像素 18bits 的 262K 颜色显示。芯片也内建几何绘图引擎，支持画点、画线、画曲线、椭圆、三角形、矩形、圆角矩形等功能，同时内嵌的硬件图形加速引擎 (BTE) 提供了命令类型的图形操作，如显示旋转、画面镜射、画中画 (PIP/子母画面) 及图形混合透明显示等功能，

ShenZhen Yes-Display International Technology CO.,LTD. 深圳市亿显国际科技有限公司			4.3 Inch UART Display Module 4.3 寸串口显示屏	
File NO.		REV	A/01	http://www.yes-display.com

若是配合的上、下位机软件更能发挥其显示效率，而不必为了 TFT 屏而去升级 MCU。强大的显示功能非常适合用在有 TFT-LCD 屏的电子产品上，或是原使用单色屏而想进行升级的产品，如各式智能家电、汽机车仪表盘、多功能事务机、工业控制、电子仪器、医疗设备、人机接口、检测设备等产品。下图为产品的应用方块图：

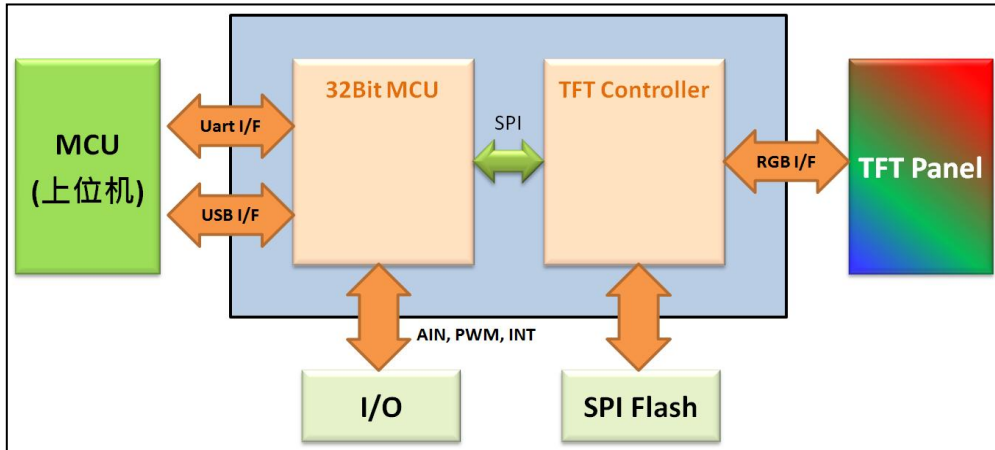

Figure 1: Application Block Diagram

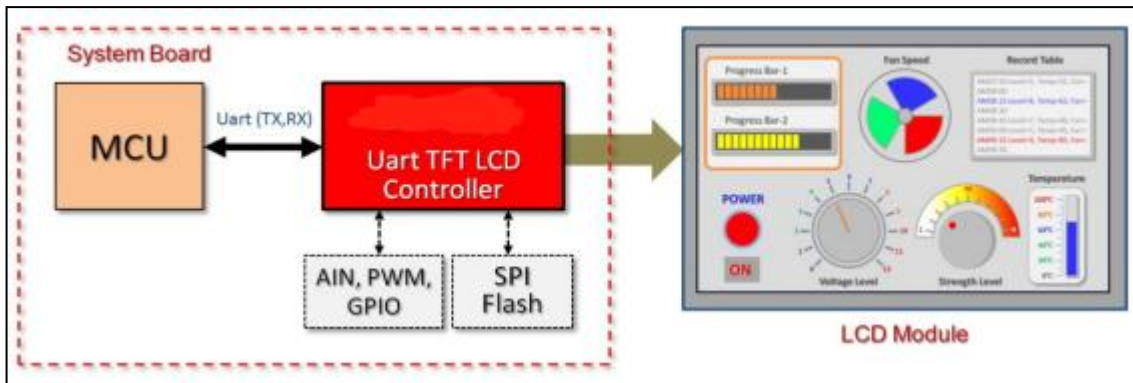

Figure 2-2: Application Block Diagram

ShenZhen Yes-Display International Technology CO.,LTD. 深圳市亿显国际科技有限公司			4.3 Inch UART Display Module 4.3 寸串口显示屏	
File NO.		REV	A/01	http://www.yes-display.com

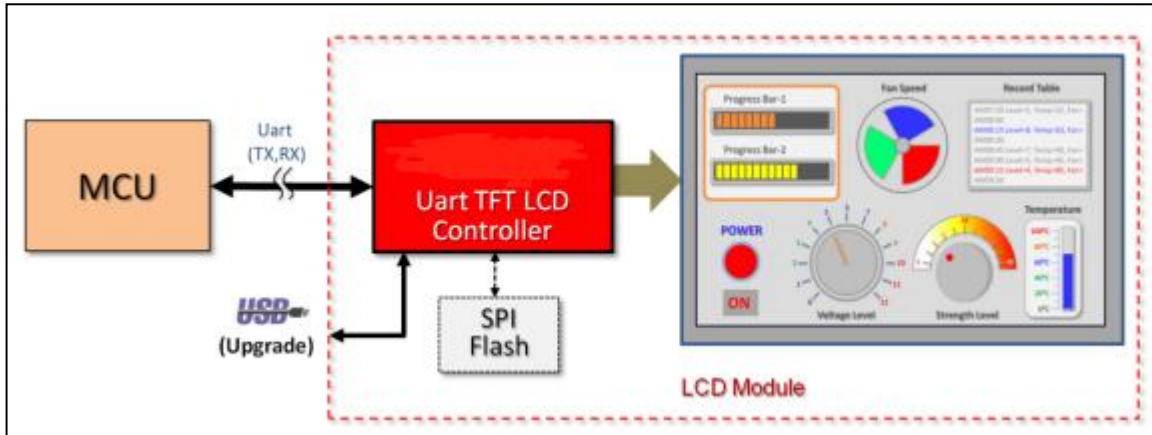

Figure 2-3: Application Block Diagram

The serial Uart TFT panel of YS-88 also supports the data update of the internal core main program of YS-88 or SPI Flash through the USB interface. Please refer to the schematic diagram and Chapter 6 of the AP note.

The "TFT Panel" that mentioned below in this application note are means "Serial Uart TFT Panel".

工业串口屏还支持用 USB 接口更新，可以用 USB 接口对 MCU 内部核心主程序或是 SPI Flash 进行数据更新，请参考升级说明。

ShenZhen Yes-Display International Technology CO.,LTD. 深圳市亿显国际科技有限公司			4.3 Inch UART Display Module 4.3 寸串口显示屏	
File NO.		REV	A/01	http://www.yes-display.com

2.1 The Frame of Serial Uart Interface Panel / 工业串口屏的软硬件架构

Serial Uart interface panel is added MCU and TFT controller on the TFT display module, the MCU is responsible for receiving from the remote mainboard interface port (Uart) command, then based on the defined commands to show images or animations, remote motherboard MCU don't need to write complex applications for showing images.

工业串口屏是在 TFT 显示模块上加上 MCU 及 TFT 控制器，该 MCU 负责接收远程主板送来的串口（Uart）指令，然后依据这些定义好的指令去显示出图片或是动画，远程主板上的 MCU 不需要为了繁琐的图片显示去编写复杂的程序，因此 TFT 工业串口屏实际上就是一种指令屏的架构。

TFT Panel and remote MCU mainly communicate through RS232 or RS485 interface. If the distance between the remote MCU and TFT Panel is very close (~30cm), the Uart output and input of the remote MCU can be directly connected to the TFT panel, as shown in the following diagram:

TFT 工业串口屏对主控端主要是透过 RS232 接口来通讯，如果主控端与 TFT 工业串口屏的距离很近（~30cm 内），可以将主控端 MCU 的 Uart 输出输入口直接接到 LT688 串口屏上的 Uart 输出输入口，如下图所示：

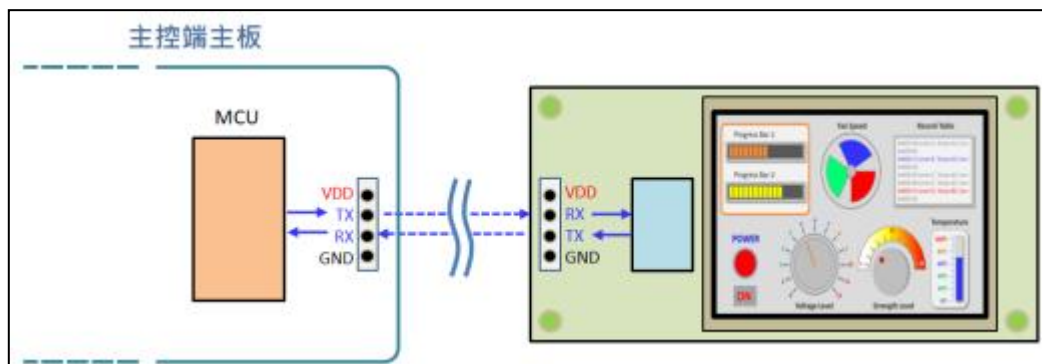
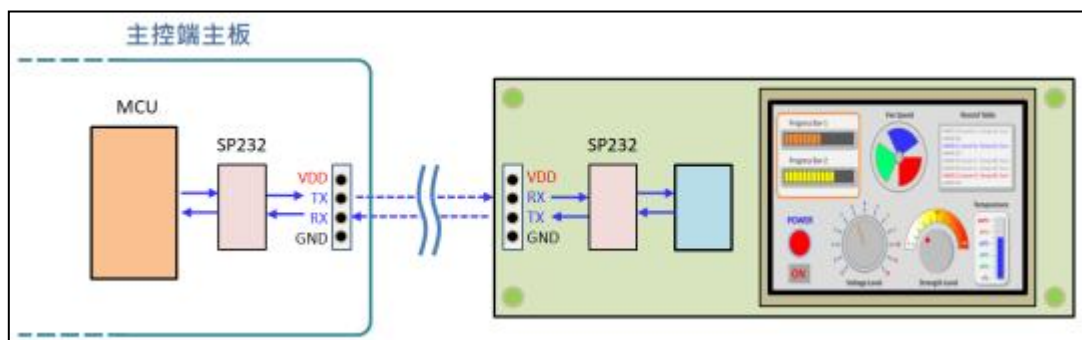

Figure1-4: Connection Diagram - 1

In order to guarantee the communication effect over a long distance, the special driver chip of RS232 or RS485 is usually needed. As shown in the following diagram:

如果要达到较远距离的通讯效果，通常需要加上 RS232 的专用驱动芯片，下图为主控端与串口屏的 RS232 驱动 IC 接口示意图：



ShenZhen Yes-Display International Technology CO.,LTD. 深圳市亿显国际科技有限公司			4.3 Inch UART Display Module 4.3 寸串口显示屏	
File NO.		REV	A/01	http://www.yes-display.com

Figure 1-5: Connection Diagram-MCU-RS232

Before using a TFT panel needs to be developed by computer develop software, Yes-Display provides (UartTFT_Tool.exe) and (UI_Editor.exe), both develop tools are for PC/NB on Windows environment, and can set up and develop TFT panel separately. When developing with them, Bin files will be generated for images, texts, animations and other information. Developers must burn Bin files into SPI Flash through SPI Flash programmer. Then through USB to Uart (RS232) to simulate the display screen of TFT panel. That is to do the early verification of TFT panel display screen.

在使用串口屏之前必须要用上位机软件做开发，使用公司提供了图文整合编译器 (UartTFT_Tool.exe) 及 图文 UI 编辑器 (UI_Editor.exe) 两种上位机软件，两者都可以单独对工业串口屏进行设置及显示功能的开发，上位机软件开发时会将使用到的图片、文字、动画等信息产生 Bin 檔，开发者必须透过 SPI Flash 烧录器将 Bin 檔烧录到 SPI Flash 内，然后透过 USB 转 Uart (RS232) 的控制线对工业串口屏进行模拟，也就是做 TFT 屏显示画面的前期验证。

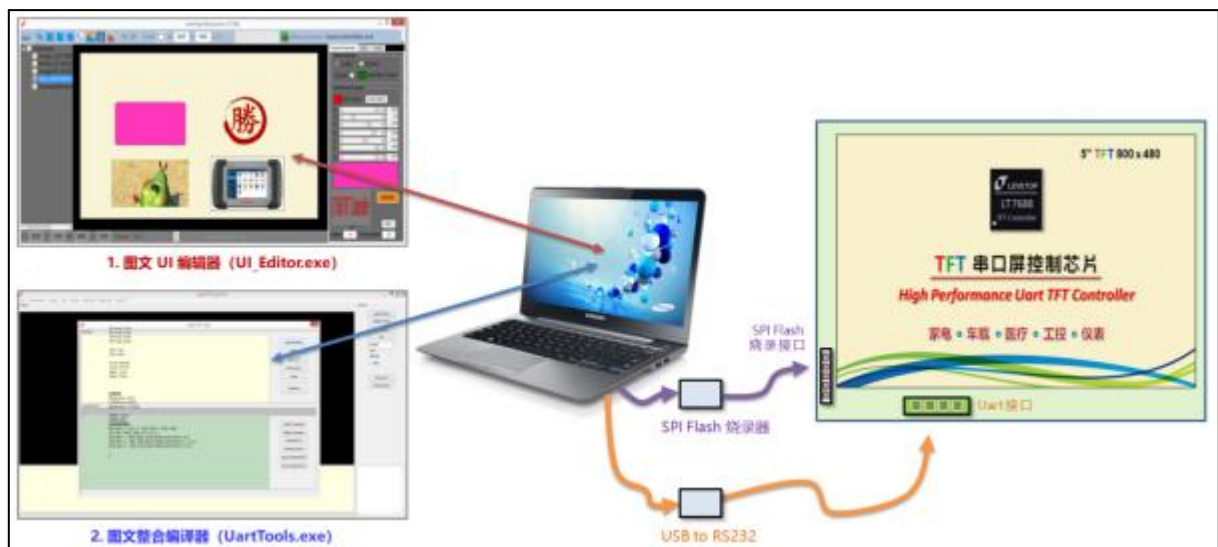
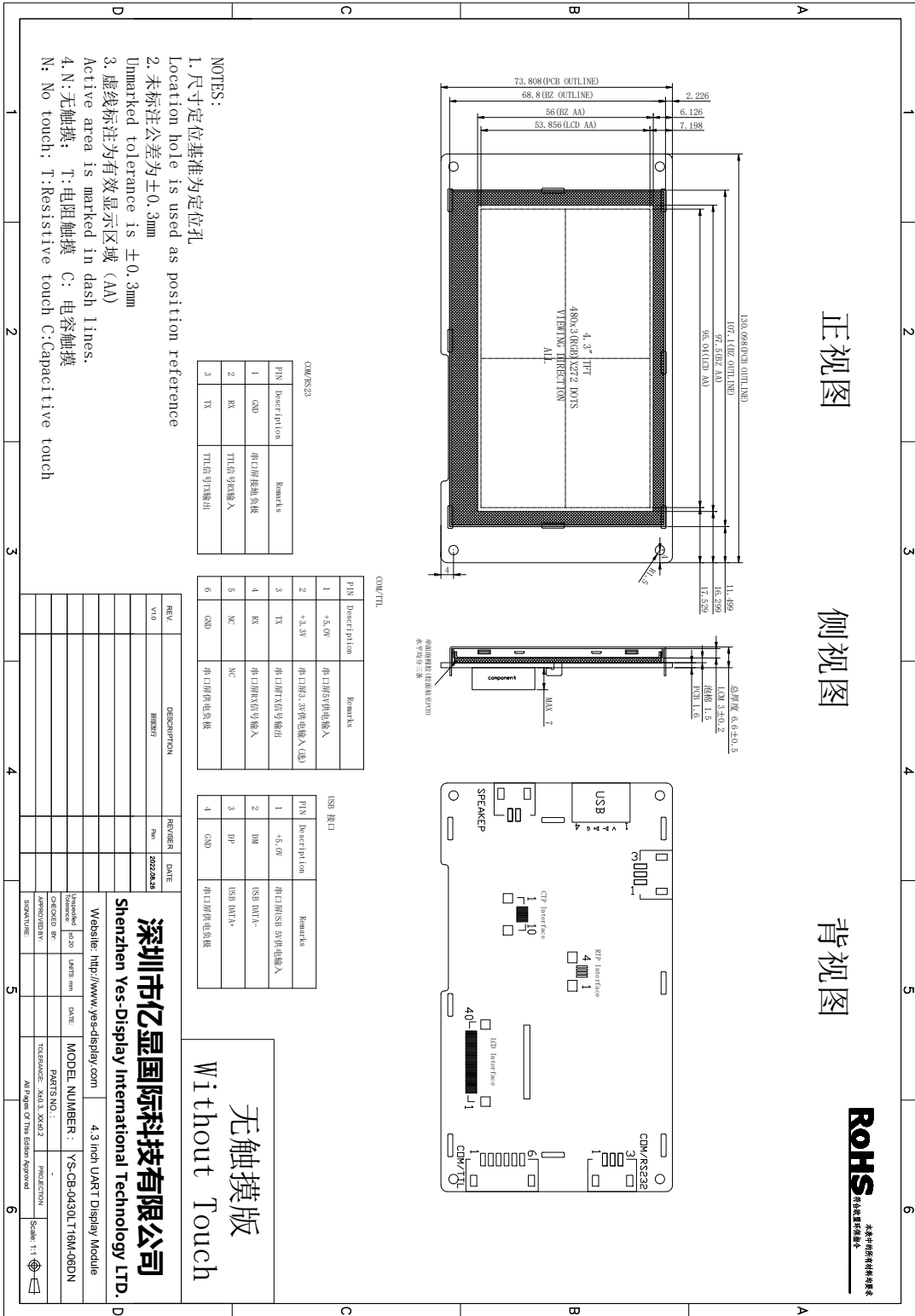
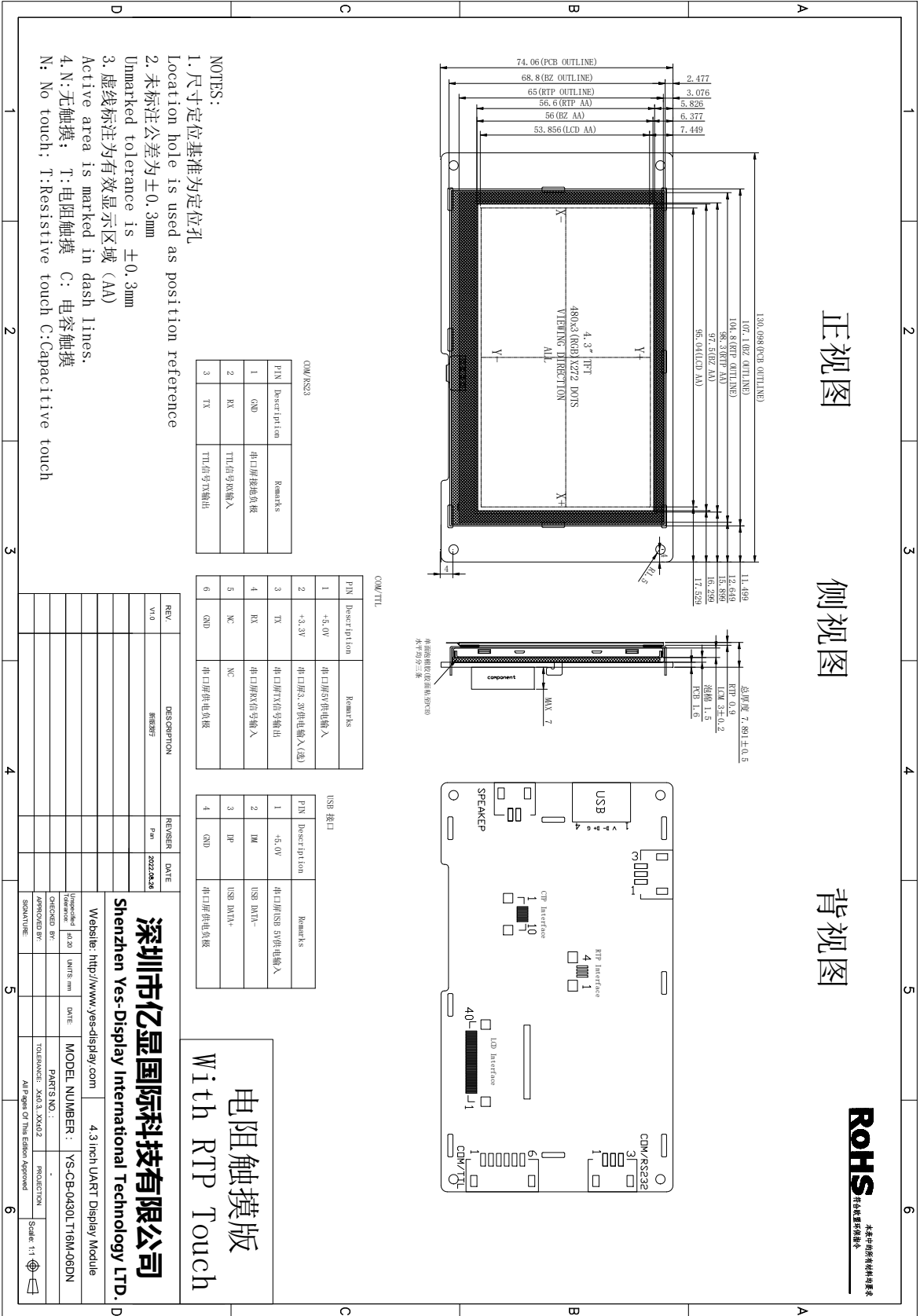

Figure 1-6: Schematic Diagram Of Developed By Using Yes-Display' s Develop Tools

3. Outline Dimensions / 产品尺寸





正视图

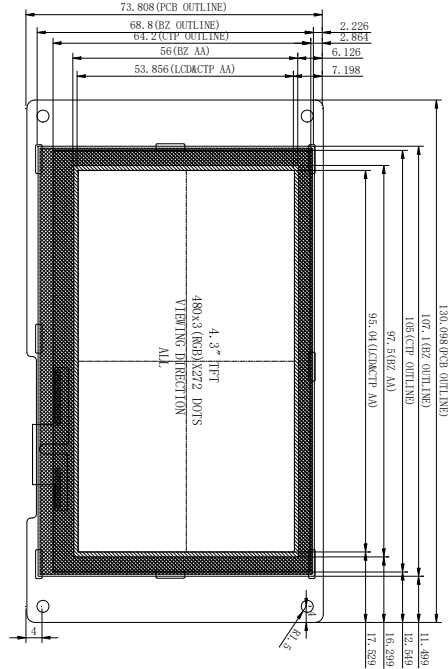

侧视图

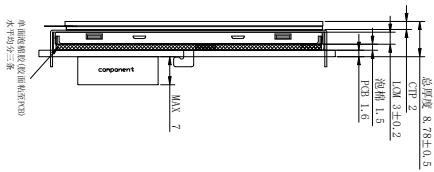

背视图

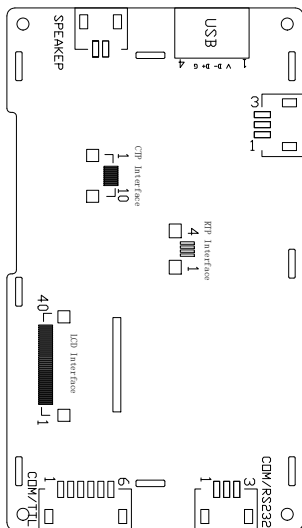

NOTES:
 1. 尺寸定位基准为定位孔
 Location hole is used as position reference
 2. 未标注公差为±0.3mm
 Unmarked tolerance is ±0.3mm
 3. 虚线标注为有效显示区域 (AA)
 Active area is marked in dash lines.
 4. N: 无触摸; T: 电阻触摸 C: 电容触摸
 N: No touch; T: Resistive touch C: Capacitive touch

Pin	Description	Remarks
1	GND	串口屏接地负极
2	RX	TTL信号接收输入
3	TX	TTL信号TX输出

Pin	Description	Remarks
1	+5.0V	串口屏供电电源输入
2	+3.3V	串口屏3.3V供电电源输入(选)
3	TX	串口屏TX信号输出
4	RX	串口屏RX信号输入
5	NC	NC
6	GND	串口屏供电负极

Pin	Description	Remarks
1	+5.0V	串口屏USB 5V供电电源输入
2	DM	USB DATA-
3	DP	USB DATA+
4	GND	串口屏供电负极

电容触摸版
 With CTP Touch

REV	DESCRIPTION	REVISION	DATE
V1.0	初版	20220404	

深圳市亿显国际科技有限公司
 Shenzhen Yes-Display International Technology LTD.

Website: <http://www.yes-display.com>

4.3 inch UART Display Module

MODEL NUMBER: YS-CB-0430LT16M-06DC

PARTS NO.: -

PRODUCTION Scale: 1:1



ShenZhen Yes-Display International Technology CO.,LTD. 深圳市亿显国际科技有限公司			4.3 Inch UART Display Module 4.3 寸串口显示屏	
File NO.		REV	A/01	http://www.yes-display.com

4. Interface Definition / 接口定义

4.1 Connect Interface Definition / 通讯接口定义

PIN / 序号	Definition / 定义	Functional Description / 功能描述
1	+5.0V	Module +5.0V input / 串口屏 5V 供电输入
2	+3.3V	Module +3.0V input / 串口屏 3V 供电输入 (首选 5V 供电, 次选 3.3V 供电)
3	TX	UART(TTL) TX single / 串口发信号 (TTL)
4	RX	UART(TTL) RX single / 串口收信号 (TTL)
5	PWM01	UART update IO, connect to GND when updating / 串口屏升级控制口, 升级串口屏时需将此接口接至 GND
6	GND	Power ground / 供电负极

4.2 USB Interface Definition / USB 接口定义

PIN / 序号	Definition / 定义	Functional Description / 功能描述
1	+5.0V	USB +5.0V input / 串口屏 USB 5V 供电输入
2	DM	USB DATA-
3	DP	USB DATA+
4	GND	Power ground / USB 供电负极
5	GND	Power ground / USB 供电负极

ShenZhen Yes-Display International Technology CO.,LTD. 深圳市亿显国际科技有限公司			4.3 Inch UART Display Module 4.3 寸串口显示屏	
File NO.		REV	A/01	http://www.yes-display.com

5. Product Technical Parameters / 产品技术参数

5.1 Product Parameters / 产品参数

MCU Chip-Set	核心处理器	32 ARM MCU	32 位双核处理器
Protocol type	协议类型	UART/TTL	UART/TTL 组态指令集
Size	尺寸	4.3 inch	4.3 寸
Resolution	分辨率	480*272	480*272
Storage Space	存储空间	16Mbit	标准:16Mbit(大小可选, 最大支持 1Gbit)
Font library	字库	Built-in vector font, edge anti-aliasing processing, including any size bitmap ASCII, GBK, GB2312,	内置矢量字体, 边缘抗锯齿处理, 包含任何大小点阵 ASCII、GBK、GB2312、字库;
Photo storage	图片存储	Support JPEG, PNG (half through/full through) compression, support arbitrary size image storage, support image rotation, zoom, zoom and other functions. The image compression ratio is different, this value will float up and down;	支持 JPEG、PNG (半透/全透) 压缩, 支持任意大小图片存储, 支持图片旋转、放大、缩小等功能。图片压缩比不同, 此值会上下浮动;
color	颜色	65K, 16Bit RGB	65K 色, 16 位 RGB
voltage	电压	5.0V /3.3V	5.0V /3.3V
Power consumption	功耗	Back Light Power ON: 3.5W; Back Light Power off: 1.6W	背光最亮: 3.5W; 关背光: 1.6W
Communication interface	通讯接口	RS232/TTL(Default TTL)	RS232/TTL(出厂默认 TTL)
Interface Specification	接口规格	PH2.54-6P	标准:PH2.54-6P
Images download	图片下载	UAR	UAR
RTC	实时时钟 (RTC)	RTC	支持倒计时、定时器、年月日等时间显示
PC software	配套上位机软件	YS_UI_Editor_V3.0	YS_UI_Editor_V3.0

5.2 LCD Display parameters / LCD显示屏参数

LCD type	显示器类型	4.3 inch display	TFT 4.3 寸液晶显示屏
Back light	背光灯管	LED	LED
brightness (cd/m ²)	亮度 (cd/m ²)	250	250

ShenZhen Yes-Display International Technology CO.,LTD. 深圳市亿显国际科技有限公司			4.3 Inch UART Display Module 4.3 寸串口显示屏	
File NO.		REV	A/01	http://www.yes-display.com

Back light life time (h)	背光灯寿命 (h)	>20,000	>20,000
contrast	对比度	400:1	400:1
View Angle (L/R/T/B)	视角 (L/R/T/B)	ALL	ALL

5.3 Touch Panel Parameters / 触控面板参数

Touch panel type:	触控类型:	RTP / CTP	电阻触摸屏 / 电容触摸屏
Touch Way:	触控方式:	Single, touch	单点、滑动触摸
Light Transmittance:	透光率:	80%	80%以上
Touch Times	触控次数	1,000,000 times	单点 100 万次以上

5.4 Product application characteristics / 产品应用特点

Learning cycle	学习周期	10 minutes to get familiar with the development environment, 1 day to complete the man-machine interaction design	10 分钟熟悉开发环境, 1 天完成人机交互设计
Program debugging	程序调试	The host computer is integrated with a "virtual serial port screen", which requires no hardware connection.	上位机集成了“虚拟串口屏”, 无需连接硬件,
Start-up time	启动时间	Power on the run, no system load time	上电即运行, 无系统加载时间
Configuration control	组态控件	Has buttons, text, drop-down menu, progress bar, slider, instrument, animation, two-dimensional code, curve, circular progress bar and other configuration controls	拥有按钮、文本、下拉菜单、进度条、滑块、仪表、动画、二维码、曲线、圆形进度条等各种组态控件
Online upgrade	在线升级	Support screen engineering picture, firmware, user MCU firmware online USB upgrade	支持屏幕工程图片、固件、用户 MCU 固件在线 USB 升级
Layer technology	图层技术	System built-in multiple display layers, switching faster	系统内置多个显示图层, 切换速度更快
reliability	可靠性	The products have passed the industry standard high and low temperature, ESD, group pulse and radiation tests	产品均通过行业标准的高低温、ESD、群脉冲和辐射等测试
Life time	生命周期	In stock	持续稳定供货, 不断货

5.5 Environmental testing and certification / 环境实验与认证

operating temperature	工作温度	-20~+70°C	-20~+70°C
Storage temperature	存储温度	-30~+80°C	-30~+80°C
Vibration test	震动测试	10 to 25Hz(X,Y,Z direction 2G 30)	10 to 25Hz(X, Y, Z 方向 2G 30 分钟)
ESD Test	ESD 测试	Air=±8KV, Contact=±4KV	Air=±8KV, Contact=±4KV (常规指标, 可支持更高)
High and low temperature test	高低温测试	The experimental temperature:60°C±3°C	实验温度:60°C±3°C 72H/-10°C±3°C 72H; 实验湿度:50°C±

ShenZhen Yes-Display International Technology CO.,LTD. 深圳市亿显国际科技有限公司			4.3 Inch UART Display Module 4.3 寸串口显示屏	
File NO.		REV	A/01	http://www.yes-display.com
		72H/-10°C±3°C 72H ; The humidity:50°C±3°C,90%±3% RH 72H		3°C, 90%±3% RH 72H
certification	认证	ROHS 、 CE (EMI:EN55022 Class-B)		ROHS 、 CE 认证 (EMI 等级:EN55022 ClassB 标准)

5.6 Customized development service / 定制开发服务

Customized fee	定制费用	For free when the order > 300PCS	一次性签订 300PCS 合同,可免收定制费
Communication interface	通讯接口	Can customize parallel bus, RS485 and other external communication interface	可定制并行总线、RS485 等外通讯接口
hardware circuit	硬件电路	Customize PCB size and thickness, add board-level user circuit, select the specified TFT brand	定制 PCB 尺寸厚度、添加板级用户电路、选用指定 TFT 品牌
customization	功能定制	According to the user product custom special instructions or controls, reduce the user development difficulty	根据用户产品定制特殊指令或控件, 降低用户开发难度
Design service	美工服务	Can provide graphic design and product structure design services	可提供图片美工及产品结构设计服务
others	其它	Customized to meet all user needs	按需定制, 满足用户一切需求

6. Reliability Test Conditions and Methods / 可靠性实验测试

The serial port screen has undergone a series of reliability tests: high and low temperature, ESD, pulse, radiation, touch life, etc., to ensure product quality, as shown in the following figure:

串口屏经过一系列的可靠性实验测试: 高低温, ESD, 脉冲, 辐射, 触摸寿命等测试, 确保产品品质, 如下图所示:



7. PC Software (English Part)

7.1 UI_Editor introduction





UI_Editor.exe is a visual UI compiler provided by Yes-Display. Its function is to package images, text, configuration data and other information to be used by the UI to generate BIN files according to customer requirements. Customers can use UI_Editor to make UI easily and quickly.







Notice: UI_Editor is written in the environment of Microsoft.net Framework 4.6.2, so the computer system must be installed with Microsoft.net Framework 4.6.2 to work properly.

The interface for UI_Editor consists of various buttons and screen frame, as shown below:



All UI design is completed in the screen frame, and users choose different functions to realize the design according to their needs. The detailed functions of the various function keys are as follows:

1.  Display text with images
2.  Image
3.  Button
4.  GIF
5.  Display numbers graphically
6.  Display text with font library
7.  QR code
8.  Tabulation

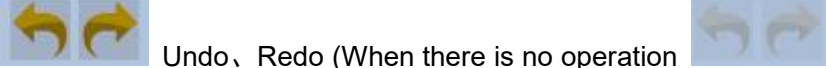
9.  Arc
10.  Progress bar
11.  SeekBar
12.  Rectangle、Rounded rectangle、Circle、Ellipse
13.  Straight line、Triangle、Quadrangle、Pentagon、Cylinder、Quadrangle prism
14.  Pointer
15.  Undo、Redo (When there is no operation)

There are several folders in the same folder as the UI_Editor.exe, and their functions are shown below.

- FONT is for The font library needed to be used
- PICFILE is for the images needed to be used
- PROJECT is for backup the project files for each Save and Build
- SOURCE is for audio and cursor Bin files



图 2: UI_Editor Folder

There are several folders in the PROJECT folder, and their action is shown below.

- BINFILE is contains the compiled BIN file, and the UserInfo and UartTFT_Flash that need to be burned are stored here.
- COMMANDFILE is for project document
- PICFILE is for the compiled image files
- SRCPIC is for the original images

深圳市亿显国际科技有限公司 ShenZhen Yes-Display International Technology CO.,LTD.			4.3 寸串口显示屏 4.3 Inch UARTDisplay Screen		
File NO.		REV	A/01	http://www.yes-display.com	

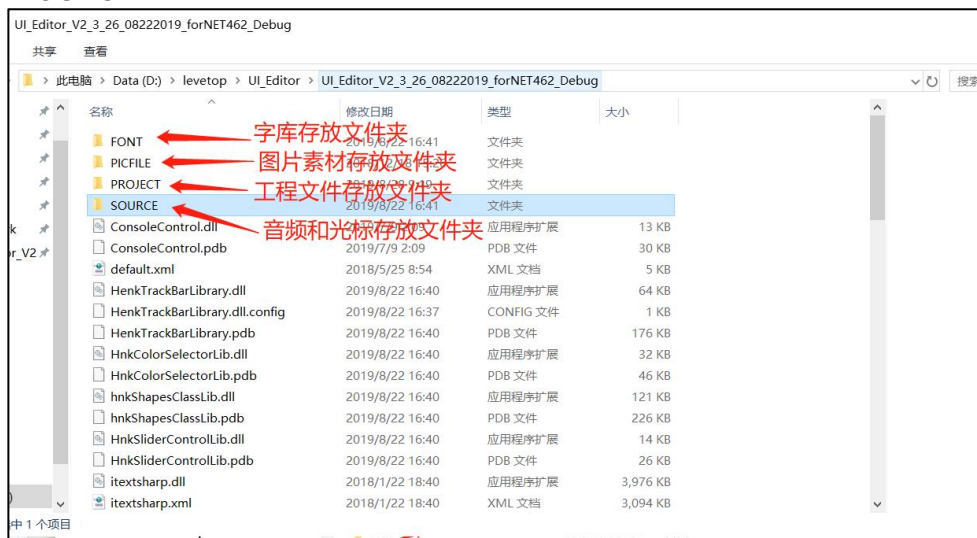

Figure 3: PROJECT folder

In Workspace options, there are three buttons: New Project, load and save. They are used to create a new project, load the project file, and save the current project. Press Save will save the project as a mainControlFiles.xml file in the COMMANDFILE folder of a time-named folder in PROJECT. The project can be reloaded by opening the maincontrolfiles.xml in the COMMANDFILE folder in the time-named folder with Load.



Figure4: UI_Editor Reload Project File

7.2 Use UI_Editor to design flow

The following figure is a detailed flowchart developed with UI_Editor. Users can also download UI_Editor demo (lt7688_ui_editor_demo.rar) from Yes-Display.com to understand the development mode more quickly. At the same time, it is recommended that the user first prepare the material according to the required function and TFT panel size. Because these images, GIF files, font library, audio files are stored in SPI Flash, the amount of data are not small. SPI Flash takes a long time to burn, so try to avoid repeatedly burning UartTFT_Flash.bin during development, so as not to delay the development progress. Yes-Display's TFT Panel development demo board suite includes SPI Flash programmer, which can be downloaded from Yes-Display.com

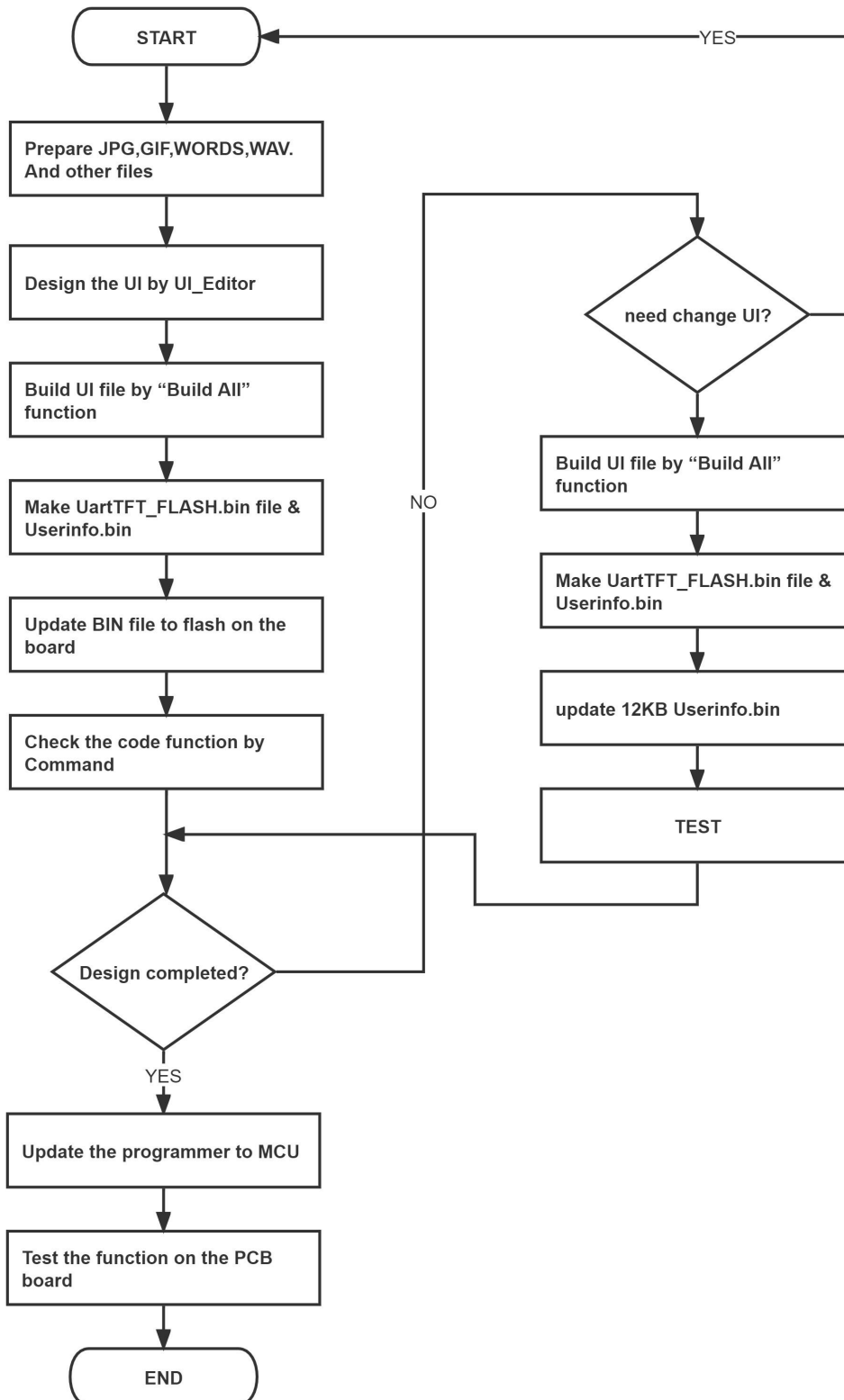

Figure 5: Design flow using UI_Editor

7. UI 设计软件介绍 (中文部分)

7.1 UI_Editor 介绍





UI_Editor.exe 是一款以串口屏为对象的 图文 UI 编译器。它的功能是根据客户的需求，将串口屏要用到的图片、文字、配置数据等信息打包生成 BIN 档。客户可以使用 UI_Editor 简单、快捷的制作 UI 界面，之后将生成的 BIN 文档烧录到 SPI Flash 中。

注意：UI_Editor 是在 Microsoft .NET Framework 4.6.2 的环境中编写出来的，所以电脑系统必须安装 Microsoft .NET Framework 4.6.2 才能正常使用。











UI_Editor 的界面由各种按钮和屏幕框组成，如下图所示：



所有的 UI 设计都在屏幕框内完成，用户根据需求选用不同的功能实现设计。其中各种功能键的详细功能如下：

-  在 UI_Editor 上以图片形式显示文字
-  添加图片按钮
-  添加控件按钮
-  添加 GIF 图按钮
-  添加数字按钮（图片）

深圳市亿显国际科技有限公司 ShenZhen Yes-Display International Technology CO.,LTD.			4.3 寸串口显示屏 4.3 Inch UARTDisplay Screen	
File NO.		REV	A/01	http://www.yes-display.com

6.  添加文字按钮（字库）
7.  添加二维码按钮
8.  添加表格
9.  添加画圆环（任意角度）
10.  添加进度条按钮
11.  添加触控滑动条按钮
12.  分别是画矩形、画圆角矩形、画圆、画椭圆
13.  分别是画线、画三角形、画四边形、画五角形、画圆柱体、画长方体
14.  添加指针按钮
15.  分别是撤回操作和恢复操作按钮（当无任何操作时初始画面是 ）

与 UI_Editor 工具同级的有几个文件夹，它们的作用如下图所示。

- FONT 文件夹用来存放需要使用的字库
- PICFILE 文件夹用来先存放需要使用到的图片文件
- PROJECT 文件夹备份着每次 Save 和 Build 的工程文件
- SOURCE 文件夹用来存放音频和光标 BIN 文件



图 2: UI_Editor 工具同级文件目录

深圳市亿显国际科技有限公司 ShenZhen Yes-Display International Technology CO.,LTD.			4.3 寸串口显示屏 4.3 Inch UARTDisplay Screen		
File NO.		REV	A/01	http://www.yes-display.com	

PROJECT 文件夹下级的工程文件里有几个文件夹，它们的作用如下图所示。

- BINFILE 文件夹存放着编译好的 BIN 文件，需要烧录的 UserInfo 和 UartTFT_Flash 就存放在此处。
- COMMANDFILE 文件夹存放着工程储存文件
- PICFILE 文件夹存放着编译后的图片文件
- SRCPIC 文件夹存放着编译前的图片

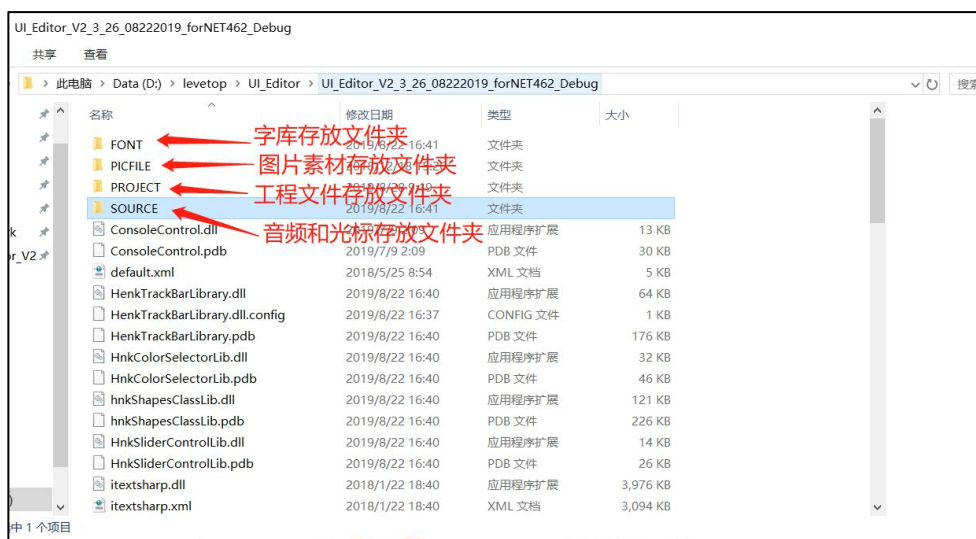

图 3: PROJECT 文件夹下级的工程文件目录

深圳市亿显国际科技有限公司 ShenZhen Yes-Display International Technology CO.,LTD.			4.3 寸串口显示屏 4.3 Inch UARTDisplay Screen		
File NO.		REV	A/01	http://www.yes-display.com	

在菜单按钮里，有 New Project、load 和 save 三个按钮。分别用来创建新工程、装载工程文件、保存当前工程。按 save 按钮会把工程以 mainControlFiles.xml 文件保存在 PROJECT 下级中以时间命名的 COMMANDFILE 文件夹里。使用 Load 功能在 PROJECT 下级找到对应时间的文件夹里 COMMANDFILE 文件夹的 mainControlFiles.xml 文件，就可以重新加载工程。



图 4: UI_Editor 重装载工程文件

7.2 使用 UI_Editor 的设计流程

下图为用图文 UI 编译器 (UI_Editor.exe) 开发的详细流程图，将更快速的了解开发模式。同时建议用户先依据所需功能及 TFT 屏幕大小准备好素材，因为这些显示图片、动画文件、文字库、声音文件等是存放在 SPI Flash 内，资料量都不小，而 SPI Flash 的烧录所需时间较长，因此尽量避免开发中反复对 SPI Flash 进行 UartTFT_Flash.bin 档的烧写，以免延误开发效率。



图 5：使用 UI_Editor 的设计流程

8. Packing Method / 包装方式

8.1 Packing Method / 包装方式

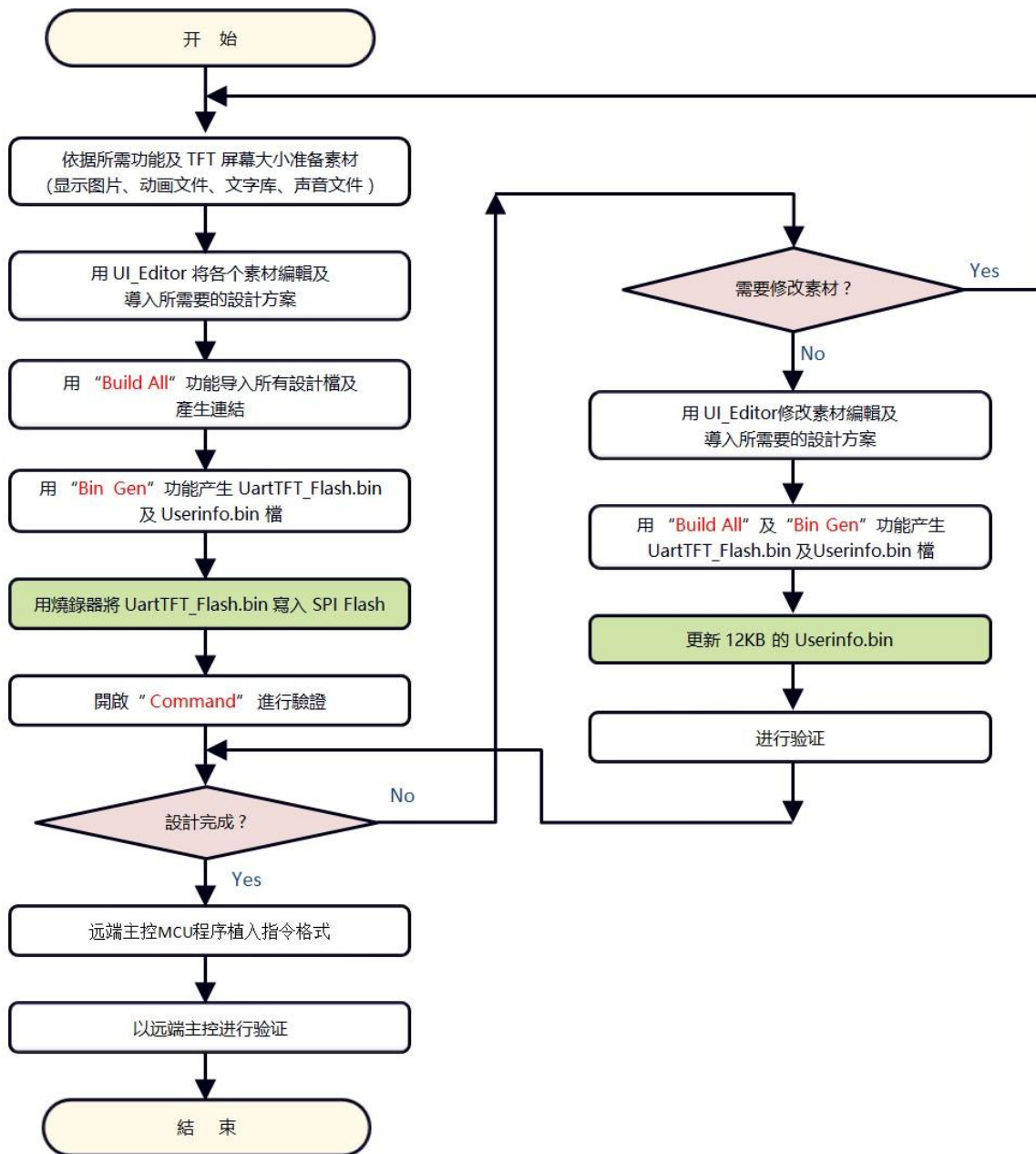
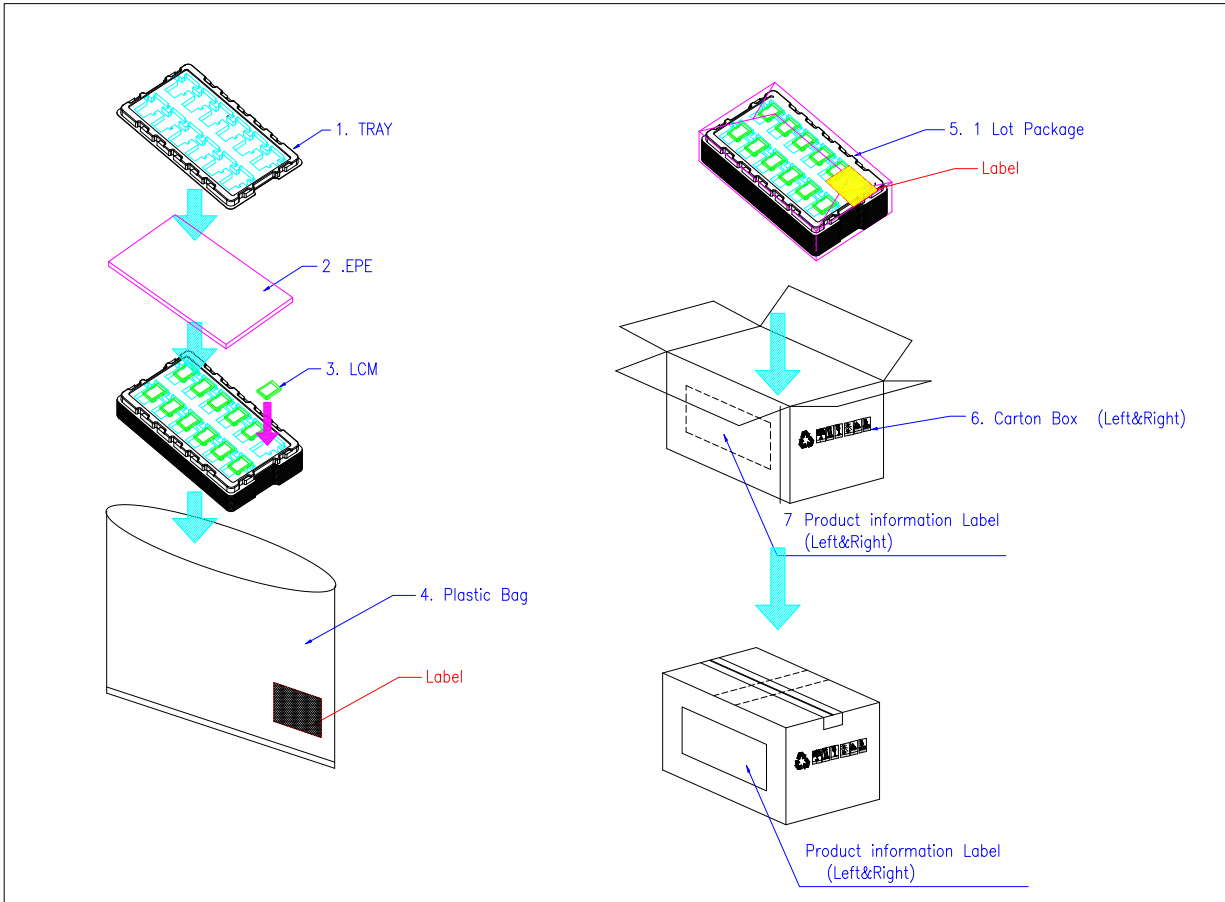

8.2 Packing Label / 产品标签

TBD